

PROPOSED HIGHWAY LANDSCAPE DEVELOPMENT PROJECT

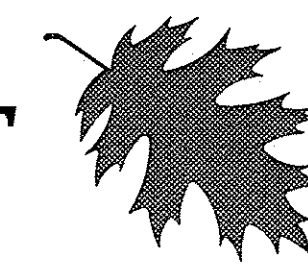

T.I.P. #	STATE PROJECT W.B.S. #	SHEET #	SHEET # TOTAL
	3703.3.24	L1	8
FED. PROJ. #	DESCRIPTION		DIVISION
	landscape		3

PROJECT: Landscape Enhancement Projects, Burgaw, North Carolina

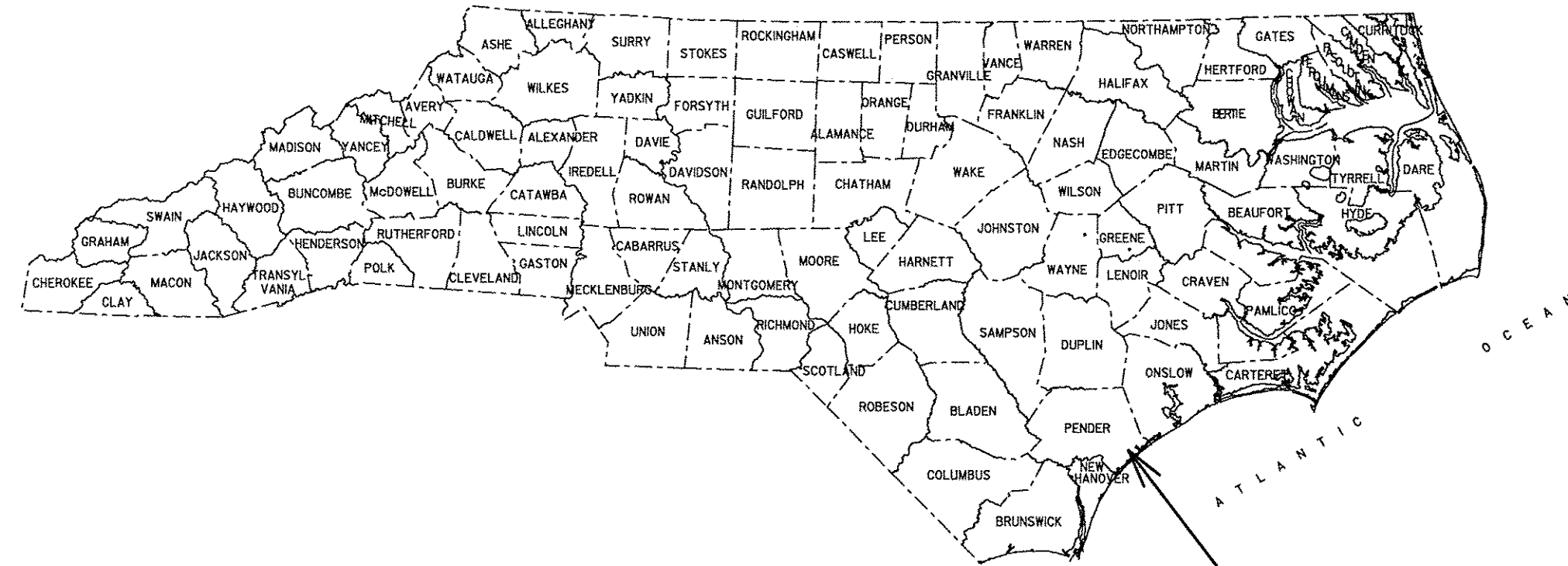

Project Location

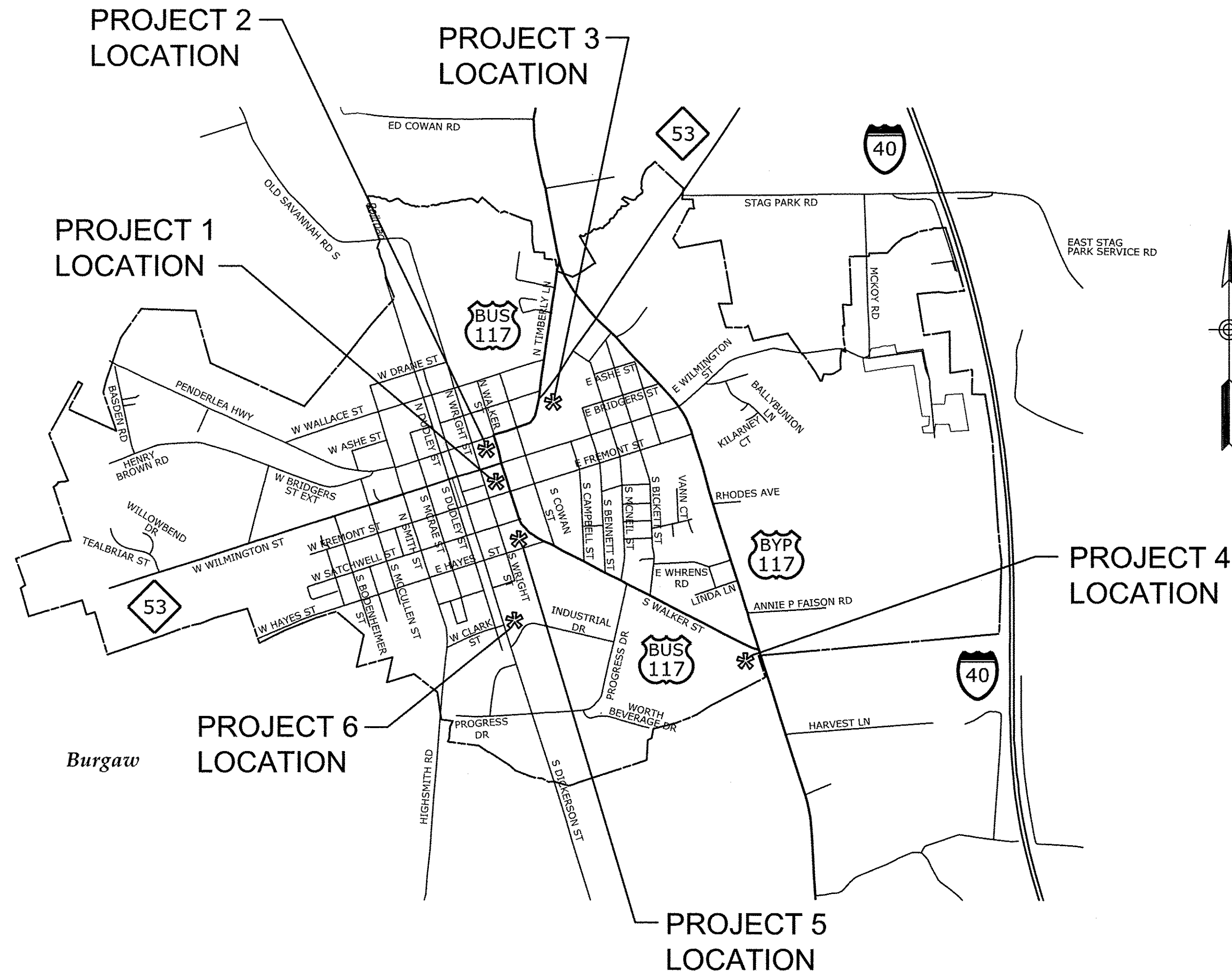

CONVENTIONAL SYMBOLS

County Line.....	-----
City or Town Line.....	-----
Exist. Right of Way Line Marker.....	-----▲-----
Prop. Right of Way Line Marker (By Others).....	-----▲-----
Prop Right of Way Line Marker (By Contract).....	-----▲-----
Exist. Control of Access Line.....	-----○-----
Prop. Control of Access Line.....	-----○-----
Property Line.....	-----
Easement Line.....	-----
Slope Stake Line.....	-----
Exist. Fence.....	-----
Prop. Woven Wire Fence.....	-----
Prop. Chain Link Fence.....	-----
Exist. Road.....	=====
Prop. Road.....	=====
Guardrail.....	=====
Survey Line.....	-----
Denotes Line Equality.....	-----
Bridge.....	=====
Culvert.....	=====
Railroad.....	=====
Woods.....	=====
Exist. Telephone Pole.....	-----●-----
Prop. Telephone Pole.....	-----○-----
Tower Pole and Line.....	-----
Exist. Power Pole.....	-----●-----
Prop. Power Pole.....	-----○-----
Sanitary Sewer Line.....	-----
Water Line.....	-----
Gas Line.....	-----
Picnic Shelter.....	-----
Regeneration.....	-----
Reforestation.....	-----

INDEX OF SHEETS:

- L1 ... TITLE SHEET
- L2 ... PROJECT 1
- L3 ... PROJECT 2
- L4 ... PROJECT 3
- L5... PROJECT 4
- L6 ... PROJECT 5
- L7... PROJECT 6
- L8.... DETAILS

PREPARED BY: NN DATE: DEC/2012

REVISIONS

DATE	DESCRIPTION

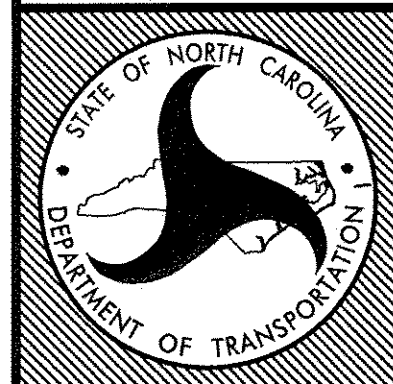

STATE OF
NORTH CAROLINA
DEPARTMENT OF TRANSPORTATION

LOCATION: Burgaw, North Carolina

TYPE of WORK: Landscape Enhancement Projects

COUNTY: Pender

2004 American Standard for Nursery Stock
2012 NCDOT STANDARD SPECIFICATIONS
PREPARED IN THE OFFICE OF:



\$\$\$\$\$SYTIME\$\$\$\$\$
\$\$\$\$\$SERIALNAME\$\$\$\$\$

EAST WILMINGTON STREET

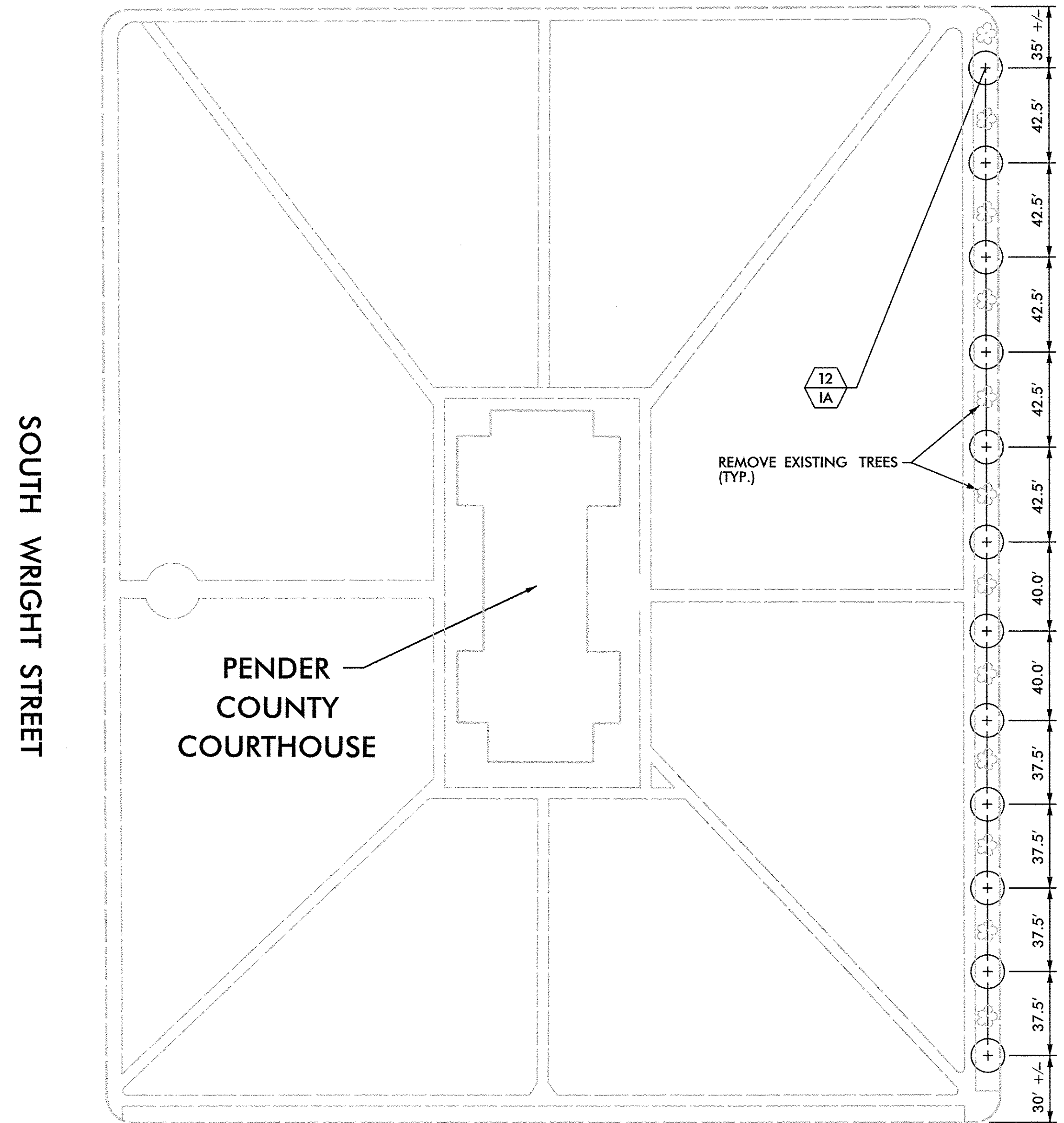

REMOVE EXISTING TREES (TYP.)

PENDER COUNTY COURTHOUSE

SOUTH WRIGHT STREET

US 117 BUSINESS (WALKER STREET)

EAST FREMONT STREET

PLANT LIST

QUANTITY	UNIT	SEC	SYMBOL	BOTANICAL NAME	COMMON NAME	CALIPER	HEIGHT	SPREAD	ROOT	COMMENTS
12	EA	1670	IA	<i>Ilex Attenuata</i> "Fosteri"	Foster Holly	5"	14' - 16'		B&B	TRIMMED UP TO 4'-5'

NOTE:

SPACING OF TREES IS APPROXIMATE AND SHOULD ONLY BE USED AS A GUIDE. ADJUST FIELD SPACING, IF THERE IS A CONFLICT WITH EXISTING UTILITY POSTS.

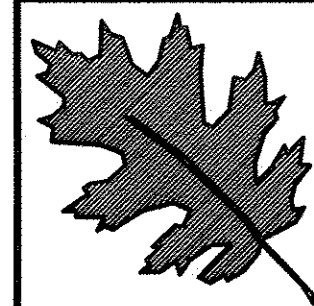
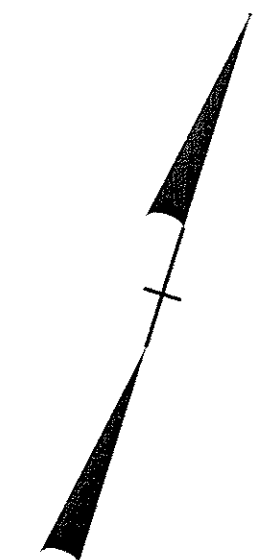

NCDOT - Division 3 - Roadside
Environmental Unit
803 Penderlea Highway Burgaw, NC 28425
Ph: 910-259-4919 Fax: 910-259-2781
Contact: Joe Chance

ARCADIS
C & M of North Carolina, Inc.
WWW.ARCADIS-US.COM
801 Corporate Center Drive, Suite 300
Raleigh, NC 27607-5073
Tel: 919/854-1282 Fax: 919/854-5448
NC License No. C-1889
Contact: Nick Nikolae

Project 1
(Pender County Courthouse Square / US 117 Bus.)
Burgaw, NC
contract #:

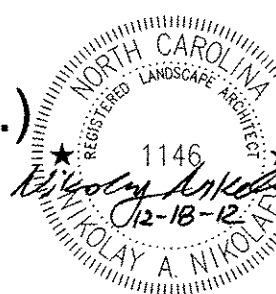

prel. design date : December/2012
checked by & date :
final design date :

Planting Plan
Scale: 1' = 40'

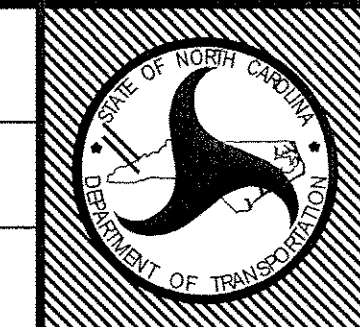

T.I.P. #
WBS # 3703.3.22
FED I.D. #
sheet no : total sheet no :
L2 8

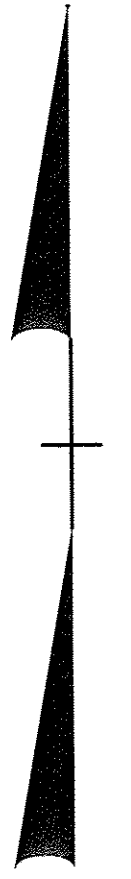
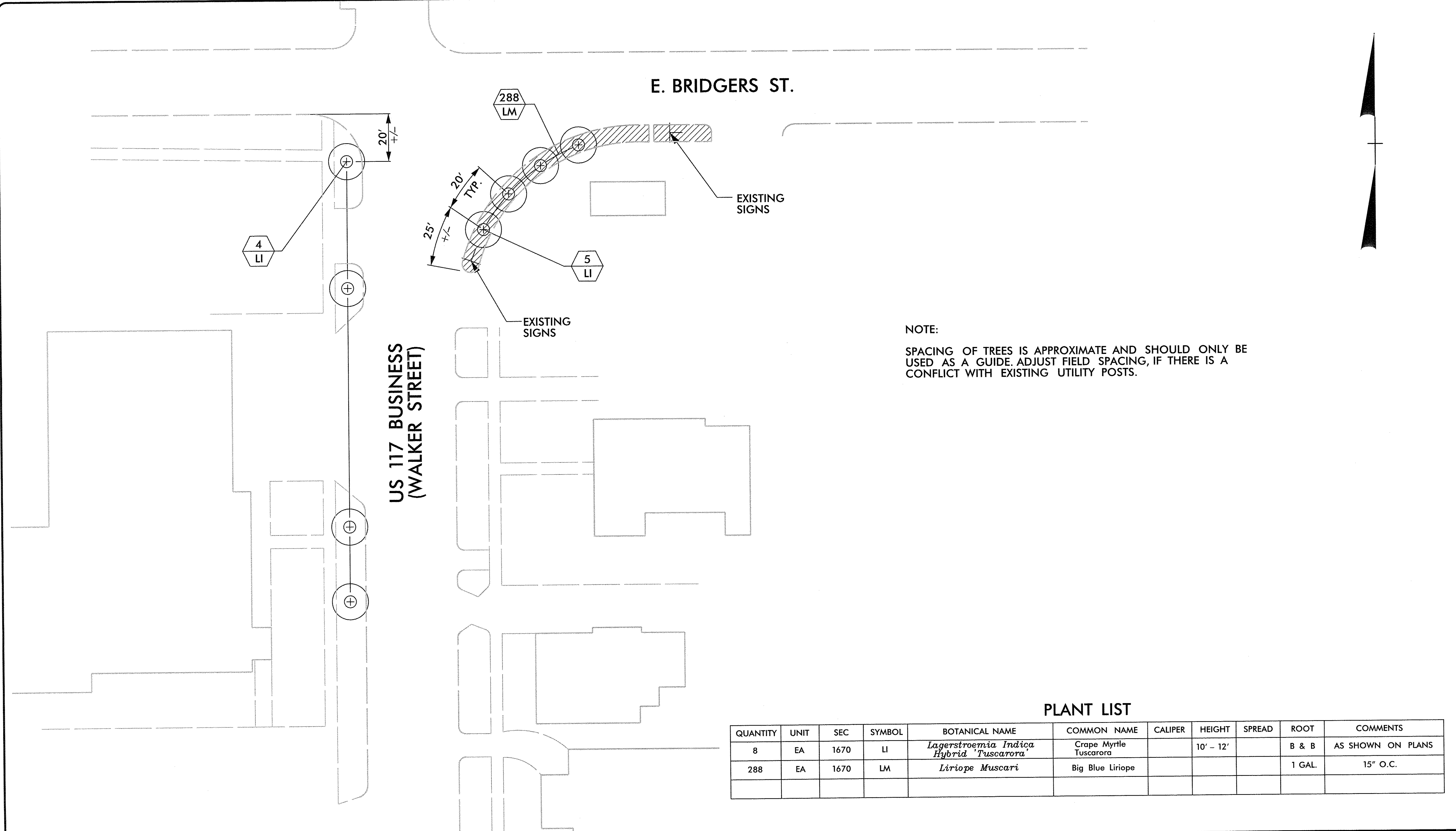

NOTE:
 SPACING OF TREES IS APPROXIMATE AND SHOULD ONLY BE USED AS A GUIDE. ADJUST FIELD SPACING, IF THERE IS A CONFLICT WITH EXISTING UTILITY POSTS.

PLANT LIST

QUANTITY	UNIT	SEC	SYMBOL	BOTANICAL NAME	COMMON NAME	CALIPER	HEIGHT	SPREAD	ROOT	COMMENTS
8	EA	1670	LI	<i>Lagerstroemia Indica Hybrid 'Tuscarora'</i>	Crape Myrtle Tuscarora		10' - 12'		B & B	AS SHOWN ON PLANS
288	EA	1670	LM	<i>Liriope Muscari</i>	Big Blue Liriope				1 GAL.	15" O.C.

\$\$\$\$SYTIME\$\$\$\$
 \$\$\$SYTIME\$\$\$\$
 \$\$\$SYTIME\$\$\$\$
 \$\$\$SYTIME\$\$\$\$

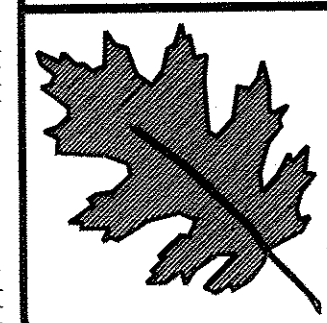

NCDOT - Division 3 - Roadside Environmental Unit
 803 Penderlea Highway Burgaw, NC 28425
 Ph: 910-259-4919 Fax: 910-259-2781
 Contact: Joe Chance

ARCADIS
 G & M of North Carolina, Inc.
 WWW.ARCADIS-US.COM
 801 Corporate Center Drive, Suite 300
 Raleigh, NC 27607-5073
 Tel: 919/854-1282 Fax: 919/854-5448
 NC License No. C-1869
 Contact: Nick Nikolcev

Project 2
 (US 117 BUS. / Walker St. / US 53 - E. Bridgers St.)
 Burgaw, NC
 contract #:

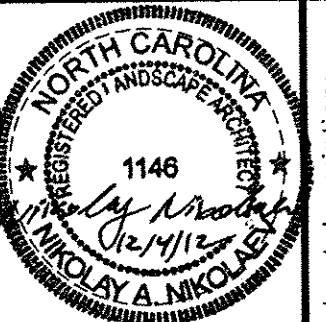

prel. design date : December/2012
 checked by & date :
 final design date :

Planting Plan
 Scale: 1" = 20'

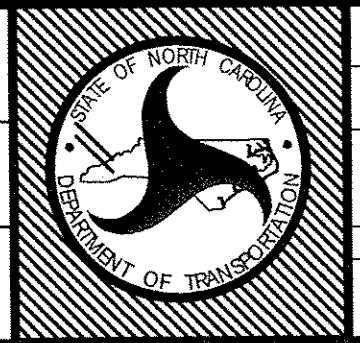

T.I.P. #
 WBS # 3703.3.22
 FED I.D. #
 sheet no : total sheet no :
L3 8

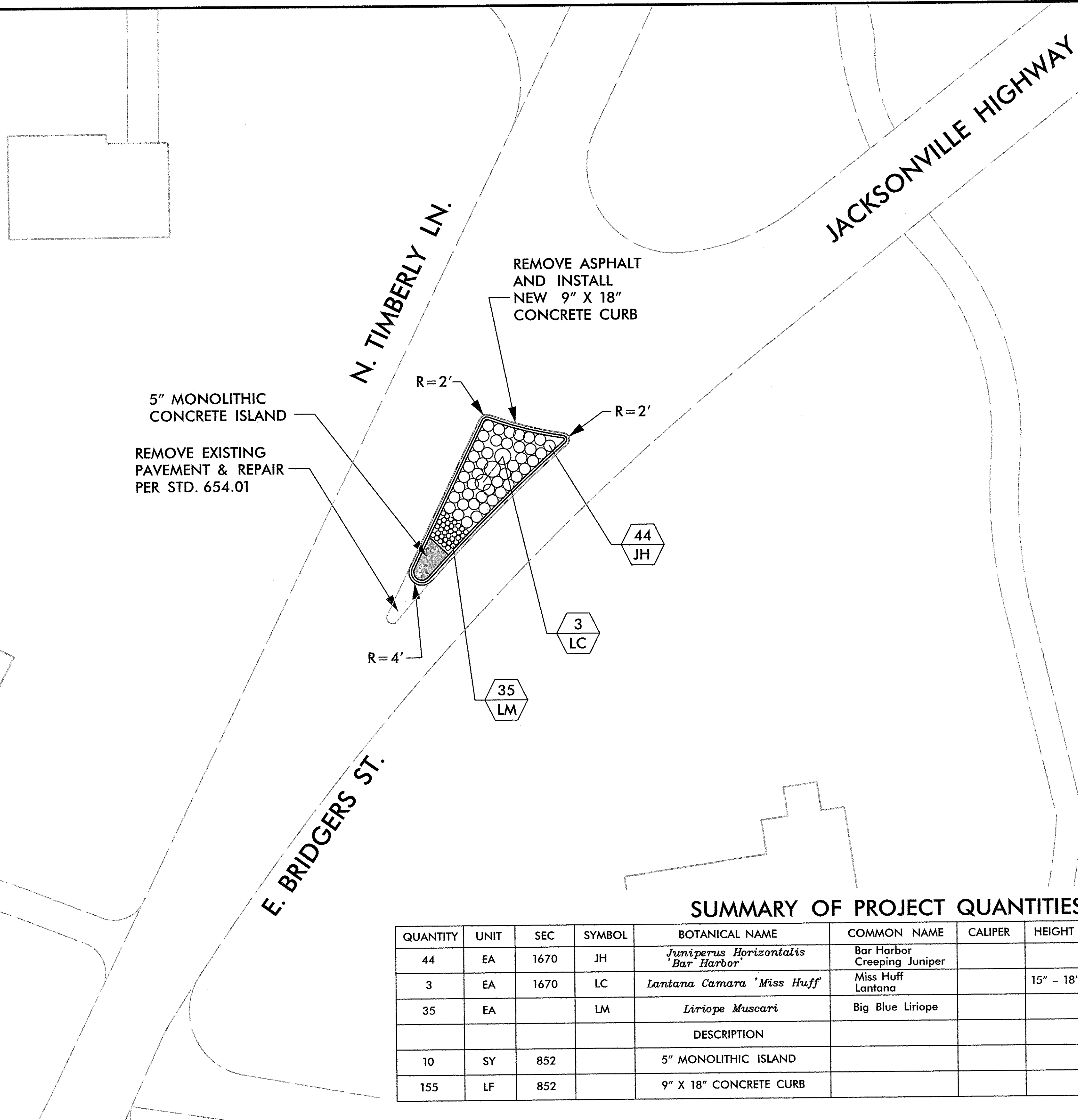
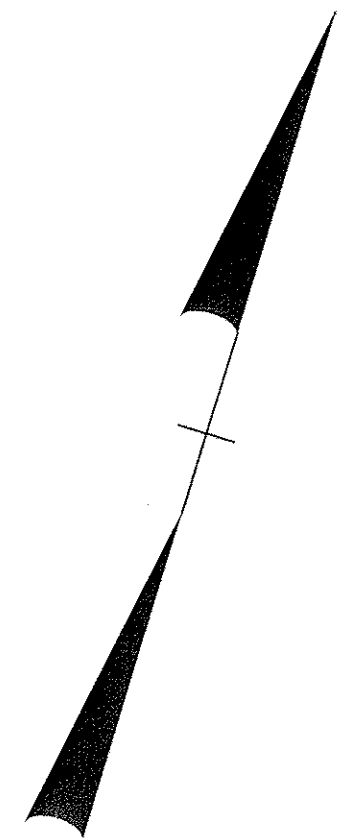

SUMMARY OF PROJECT QUANTITIES

QUANTITY	UNIT	SEC	SYMBOL	BOTANICAL NAME	COMMON NAME	CALIPER	HEIGHT	SPREAD	ROOT	COMMENTS	
44	EA	1670	JH	<i>Juniperus Horizontalis</i> 'Bar Harbor'	Bar Harbor Creeping Juniper			15" - 18"	CONT.	3' O.C. SPACING	
3	EA	1670	LC	<i>Lantana Camara</i> 'Miss Huff'	Miss Huff Lantana		15" - 18"	18" - 24"	CONT.	AS SHOWN ON PLANS	
35	EA		LM	<i>Liriope Muscari</i>	Big Blue Liriope				1 GAL.	15" O.C. SPACING	
				DESCRIPTION							
10	SY	852		5" MONOLITHIC ISLAND							
155	LF	852		9" X 18" CONCRETE CURB							

\$\$\$\$\$SYTIME\$\$\$\$\$
\$\$\$\$\$CUSTNAME\$\$\$\$\$

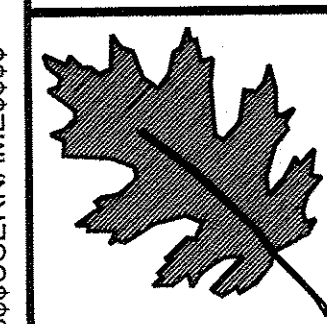

NCDOT - Division 3 - Roadside
Environmental Unit
803 Penderlea Highway Burgaw, NC 28425
Ph: 910-259-4919 Fax: 910-259-2781
Contact: Joe Chance

ARCADIS
G & M of North Carolina, Inc.
WWW.ARCADIS-US.COM
801 Corporate Center Drive, Suite 300
Raleigh, NC 27607-5073
Tel: 919/854-1282 Fax: 919/854-5448
NC License No. C-1869
Contact: Nick Nikolaeu

Project 3
(E. Bridges St. / Jacksonville Highway)
Burgaw, NC
contract #:



prel. design date : December/2012
checked by & date :
final design date :

Planting Plan
Scale: 1" = 20'

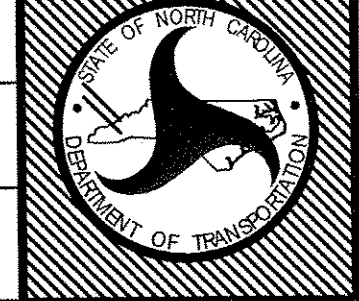

T.I.P. #
WBS # 3703.3.22
FED I.D. #
sheet no : total sheet no :
L4 8

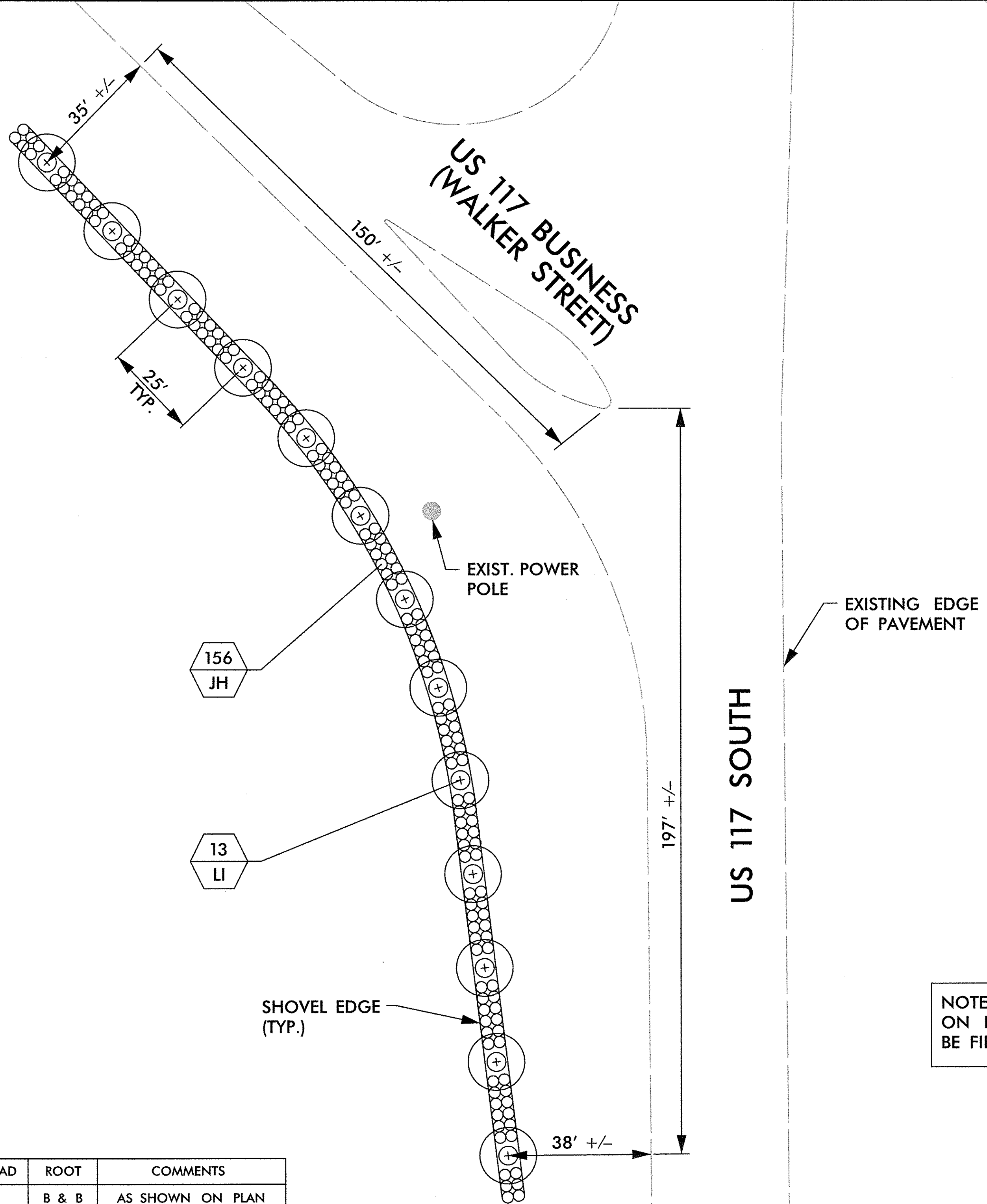

PLANT LIST

QUANTITY	UNIT	SEC	SYMBOL	BOTANICAL NAME	COMMON NAME	CALIPER	HEIGHT	SPREAD	ROOT	COMMENTS
13	EA	1670	LI	<i>Lagerstroemia Indica</i> 'Tuscarora'	Tuscarora Crape Myrtle		10' - 12'		B & B	AS SHOWN ON PLAN
156	EA	1670	JH	<i>Juniperus Horizontalis</i> 'Bar Harbor'	Bar Harbor Creeping Juniper			15" - 18"	Cont.	3' O.C. SPACING

11/15/12

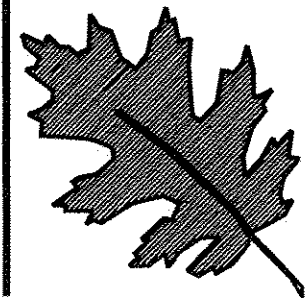

NCDOT - Division 3 - Roadside
Environmental Unit
803 Penderlea Highway Burgaw, NC 28425
Ph: 910-259-4919 Fax: 910-259-2781
Contact: Joe Chance



801 Corporate Center Drive, Suite 300
Raleigh, NC 27607-5073
Tel: 919/854-1282 Fax: 919/854-5448
NC License No. C-1869
Contact: Nick Nikolaev

Project 4
(US 117 Business / US 117)
Burgaw, NC
contract #:

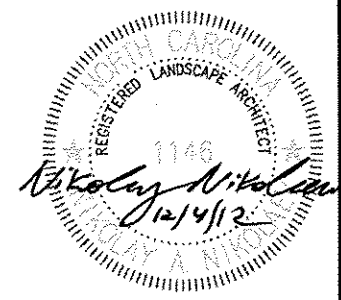

sheet description:
 prel. design date : December/2012
 checked by & date :
 final design date :

Planting Plan
 Scale: 1" = 20'

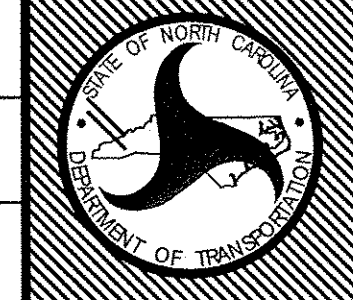

T.I.P. #
 WBS # 3703.3.22
 FED I.D. #
 sheet no : total sheet no :
L5 8

NOTE: PLANT CRAPE MYRTLE TREE AT SUNNY AREA, AVOID PINE TREES SHADED AREA.

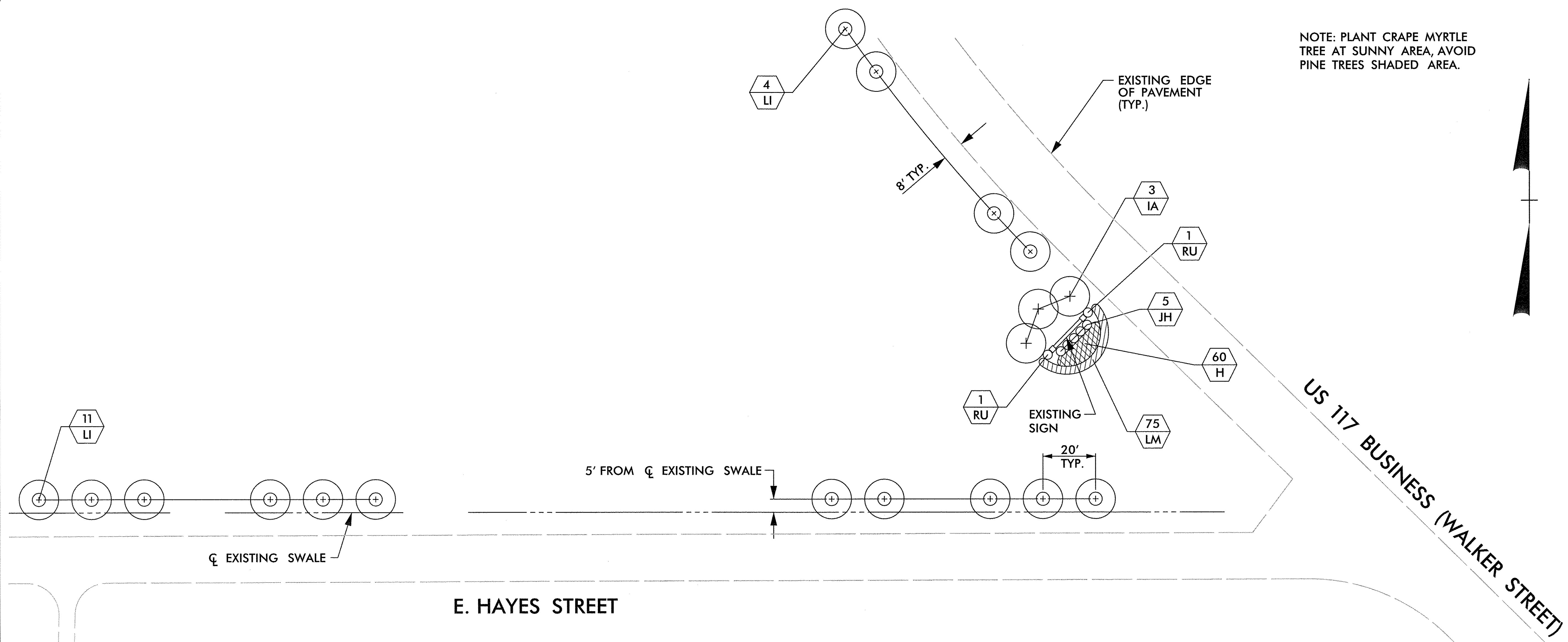

E. HAYES STREET

US 117 BUSINESS (WALKER STREET)

PLANT LIST

TYPE	QUANTITY	UNIT	SEC	SYMBOL	BOTANICAL NAME	COMMON NAME	CALIPER	HEIGHT	SPREAD	ROOT	COMMENTS
TREES	3	EA	1670	IA	<i>Ilex attenuata 'Fosteri'</i>	Foster Holly		10' - 12'		B & B	AS SHOWN ON PLANS
	15	EA	1670	LI	<i>Lagerstroemia indica 'Tuscarora'</i>	Tuscarora Crape Myrtle		10' - 12'		B & B	MULTI-STEM
SHRUBS	2	EA	1670	RU	<i>Raphiolepis umbellata Indica</i>	Indian Hawthorn		18" - 24"		CONT.	AS SHOWN ON PLANS
	5	EA	1670	JH	<i>Juniperus horizontalis 'Bar Harbor'</i>	Bar Harbor Juniper			15" - 18"	CONT.	3' O.C. SPACING
GROUND COVER	75	EA	1670	LM	<i>Liriope muscari</i>	Big Blue Liriope				1 GAL.	15" O.C. SPACING
	60	EA	1670	H	<i>Heemerocallis</i>	DayLily				1 GAL.	18" O.C. SPACING

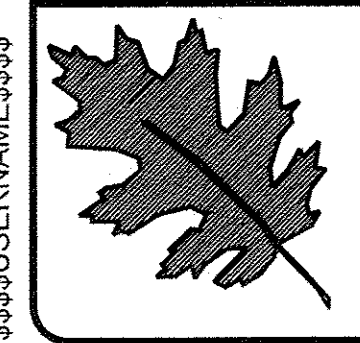

NCDOT - Division 3 - Roadside Environmental Unit
803 Penderlea Highway Burgaw, NC 28425
Ph: 910-259-4919 Fax: 910-259-2781
Contact: Joe Chance

ARCADIS
G & M of North Carolina, Inc.
WWW.ARCADIS-US.COM
801 Corporate Center Drive, Suite 300
Raleigh, NC 27607-5073
Tel: 919/854-1282 Fax: 919/854-5448
NC License No. C-1869
Contact: Nick Nikolov

Project 5
(Johnson Park - US 117 Business -Walker St. / E. Hayes St.)
Burgaw, NC
contract #:

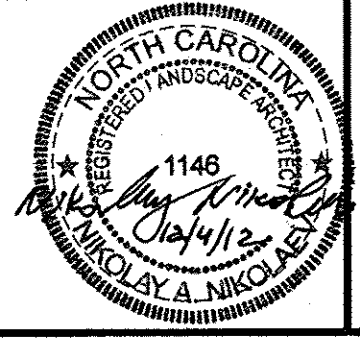

prel. design date : December/2012
checked by & date :
final design date :

Planting Plan
Scale: 1" = 20'

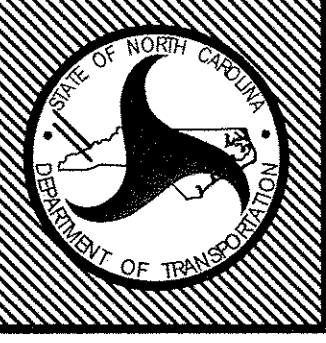

T.I.P. #
WBS # 3703.3.22
FED I.D. #
sheet no : total sheet no :
L6 8

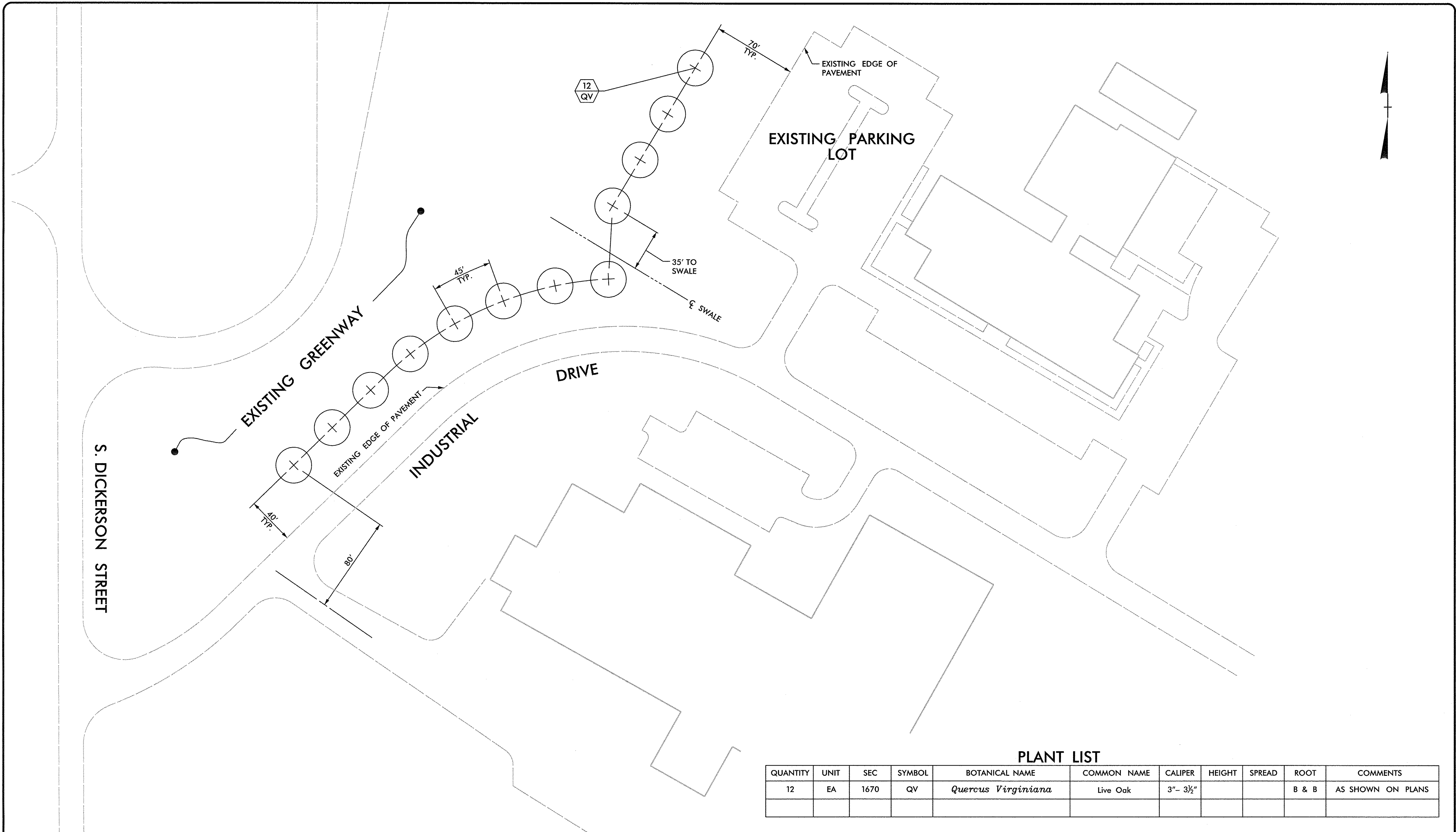

PLANT LIST

QUANTITY	UNIT	SEC	SYMBOL	BOTANICAL NAME	COMMON NAME	CALIPER	HEIGHT	SPREAD	ROOT	COMMENTS
12	EA	1670	QV	<i>Quercus Virginiana</i>	Live Oak	3"- 3½"			B & B	AS SHOWN ON PLANS

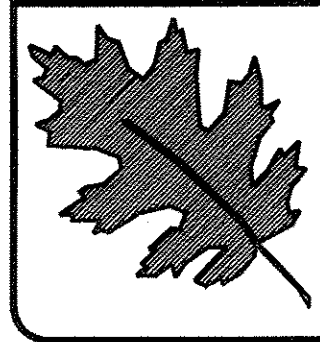

NCDOT - Division 3 - Roadside
 Environmental Unit
 803 Penderlea Highway Burgaw, NC 28425
 Ph: 910-259-4919 Fax: 910-259-2781
 Contact: Joe Chance

ARCADIS
 G & M of North Carolina, Inc.
 WWW.ARCADIS-US.COM
 801 Corporate Center Drive, Suite 300
 Raleigh, NC 27607-5073
 Tel: 919/854-1282 Fax: 919/854-5448
 NC License No. C-1869
 Contact: Nick Nikolajev

Project 6
 (Industrial Drive)
 Burgaw, NC
 contract #:

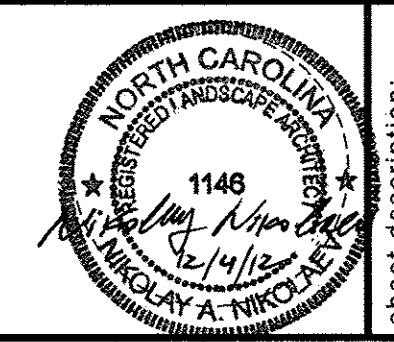

prel. design date : December/2012
 checked by & date :
 final design date :

Planting Plan
 Scale: 1" = 40'

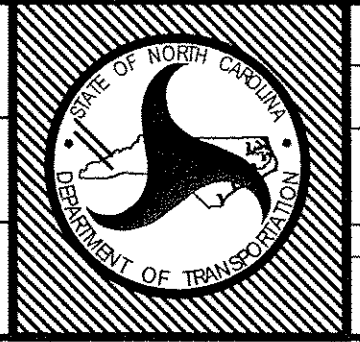

T.I.P. #
 WBS # 3703.3.22
 FED I.D. #
 sheet no : L7 total sheet no : 8

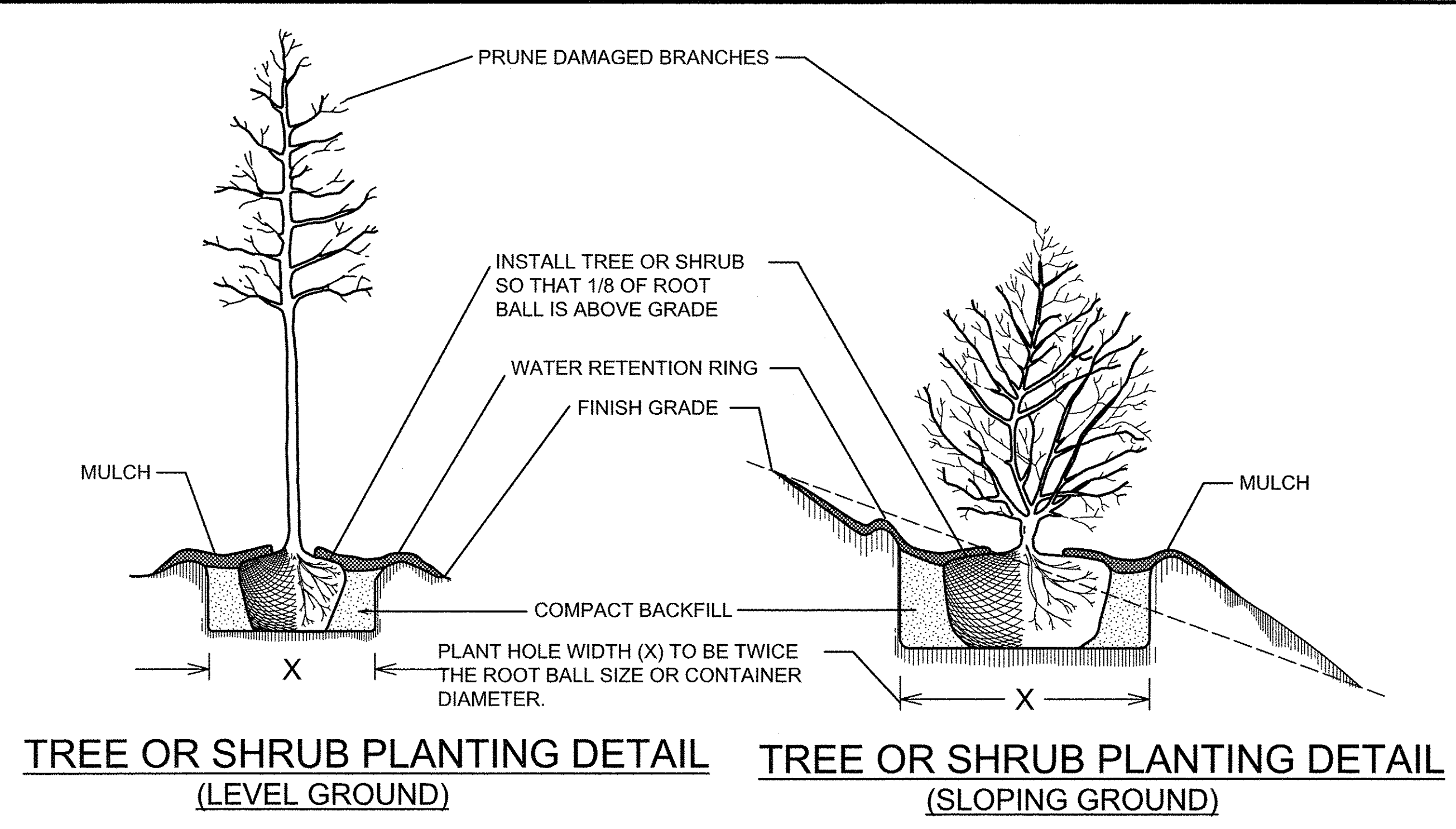

TREE OR SHRUB PLANTING DETAIL (LEVEL GROUND) **TREE OR SHRUB PLANTING DETAIL (SLOPING GROUND)**

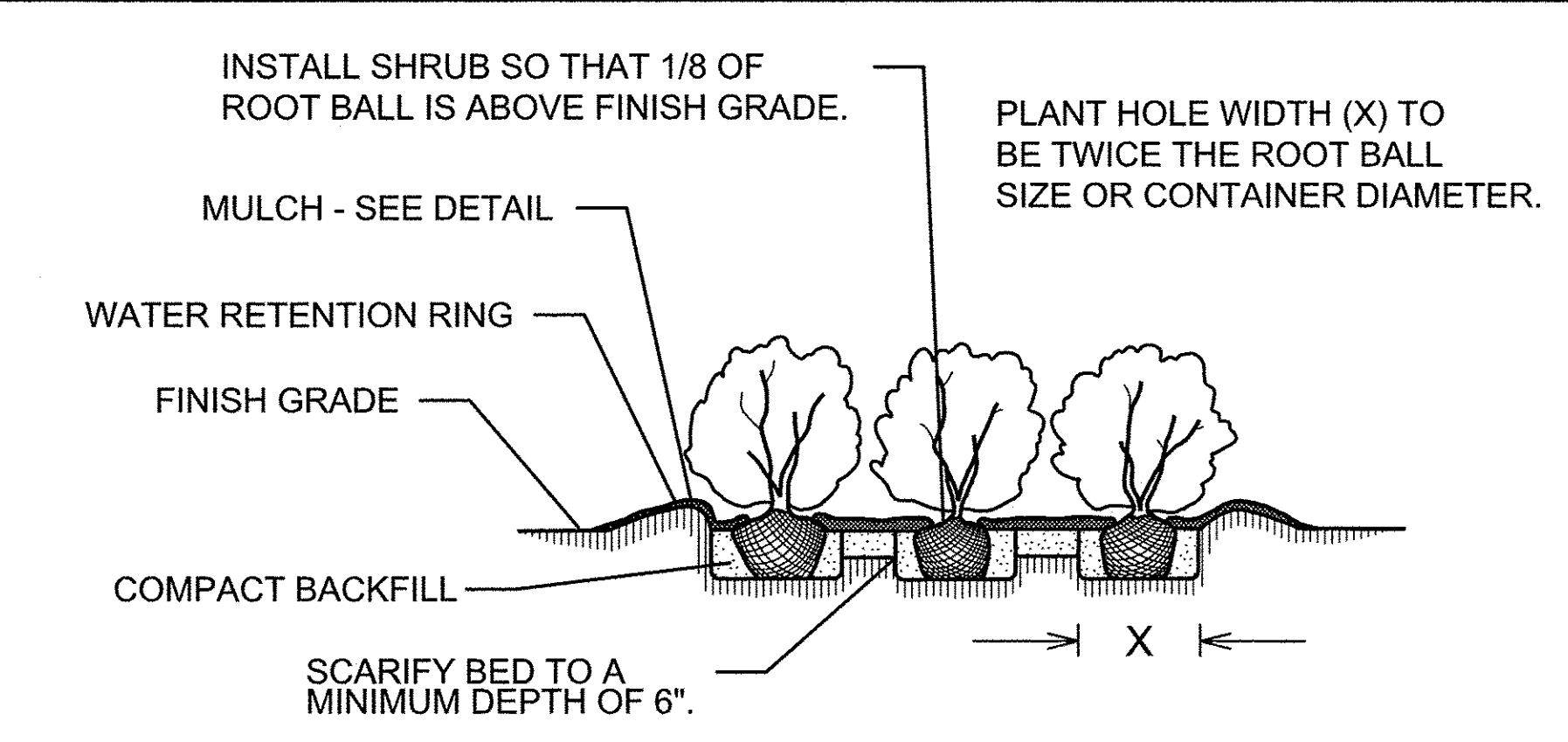
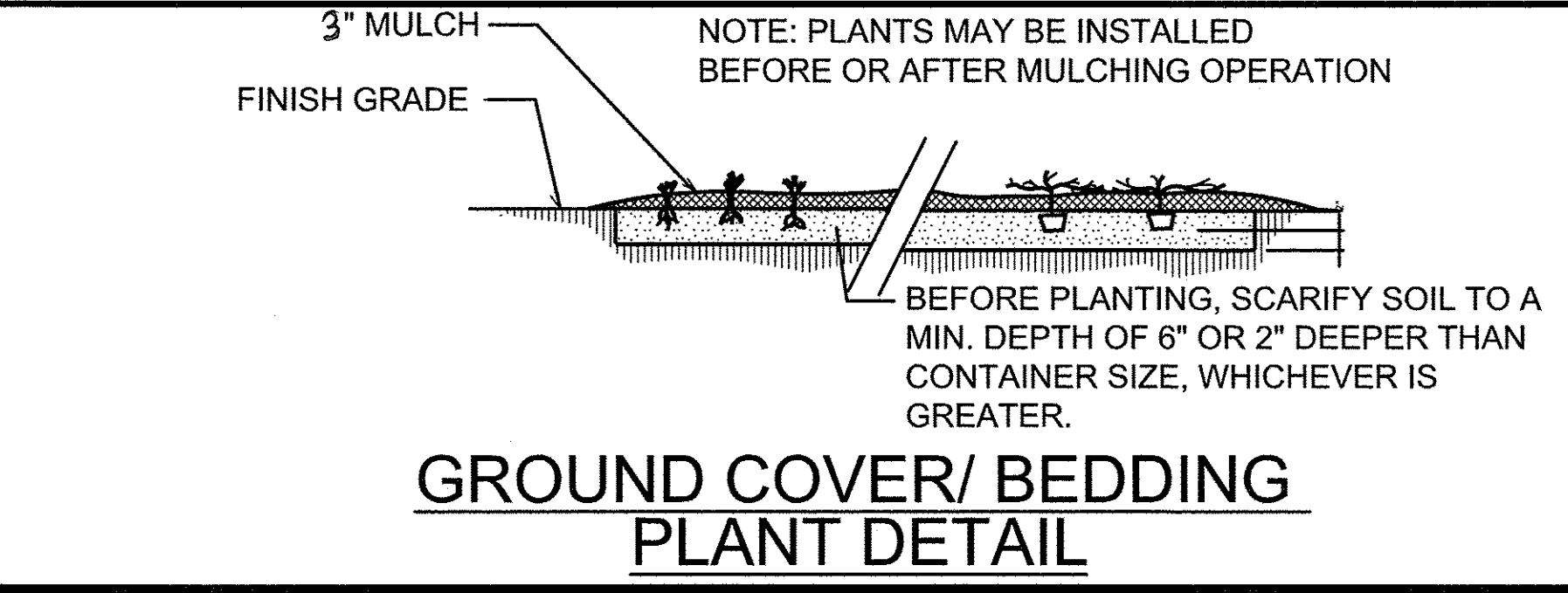

GROUND COVER/ BEDDING PLANT DETAIL **SHRUB BED PLANTING DETAIL**

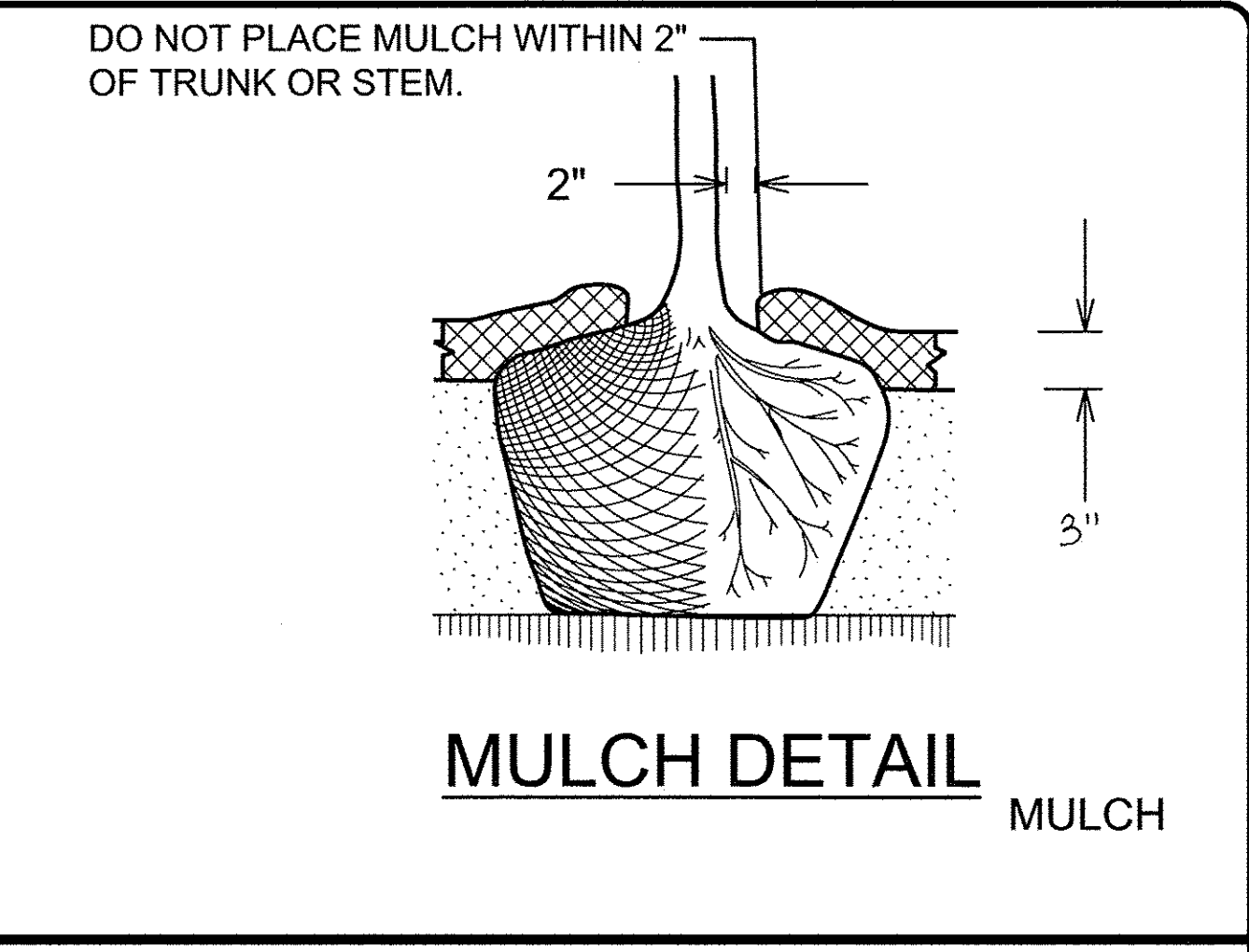

MULCH DETAIL

- NOTES:**
- SCHEDULE FOR PLANT HOLE SIZE: PLANT HOLE WIDTH (X) TO BE TWICE THE ROOT BALL SIZE OR CONTAINER DIAMETER.
 - SEE STANDARD SPECIFICATIONS FOR PLANT BED FUMIGATION AND HERBICIDAL TREATMENT.
 - APPLY FERTILIZER AT PLANTING TIME IN THE FORM OF A SLOW RELEASE PELLETT OR TABLET. APPLY AT RATE RECOMMENDED BY MANUFACTURER. BOTH RATE AND FORMULATION MUST BE APPROVED BY FIELD ENGINEER PRIOR TO APPLICATION.
 - REMOVE WIRE BASKET AND FOLD BURLAP BACK FROM TOP OF ROOT BALL BEFORE BACKFILLING IS COMPLETE.
 - ALL PRUNING TO FOLLOW STANDARD ARBORICULTURAL PRACTICES AS SPECIFIED BY INTERNATIONAL SOCIETY OF ARBORICULTURE.
 - DO NOT ATTEMPT TO STRAIGHTEN A TREE THAT HAS BEEN PLANTED AT AN ANGLE WITH THE USE OF STAKING OR GUYING. DIG TREE AND REPLANT TO UPRIGHT POSITION.

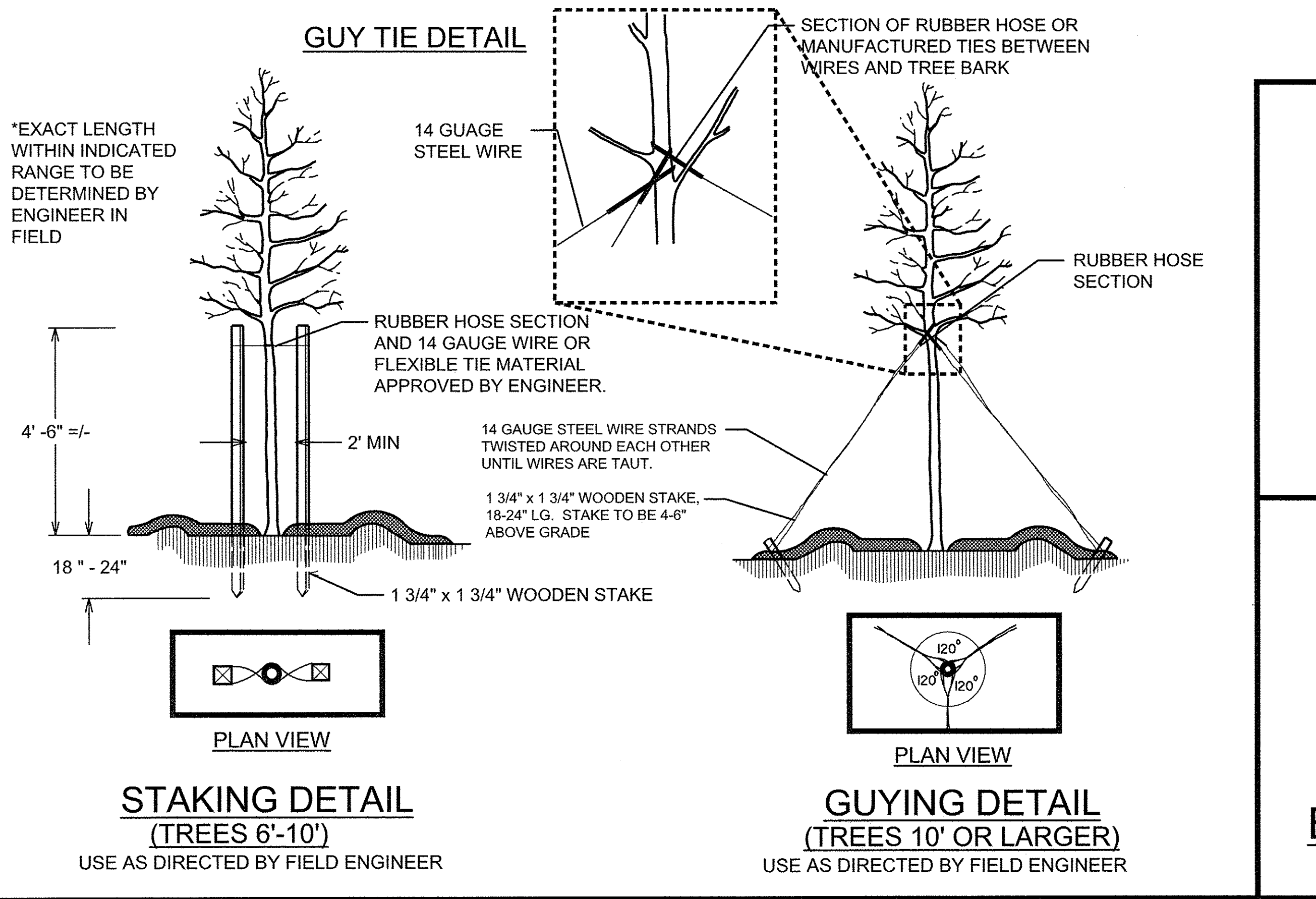

STAKING DETAIL (TREES 6'-10') **GUYING DETAIL (TREES 10' OR LARGER)**
USE AS DIRECTED BY FIELD ENGINEER

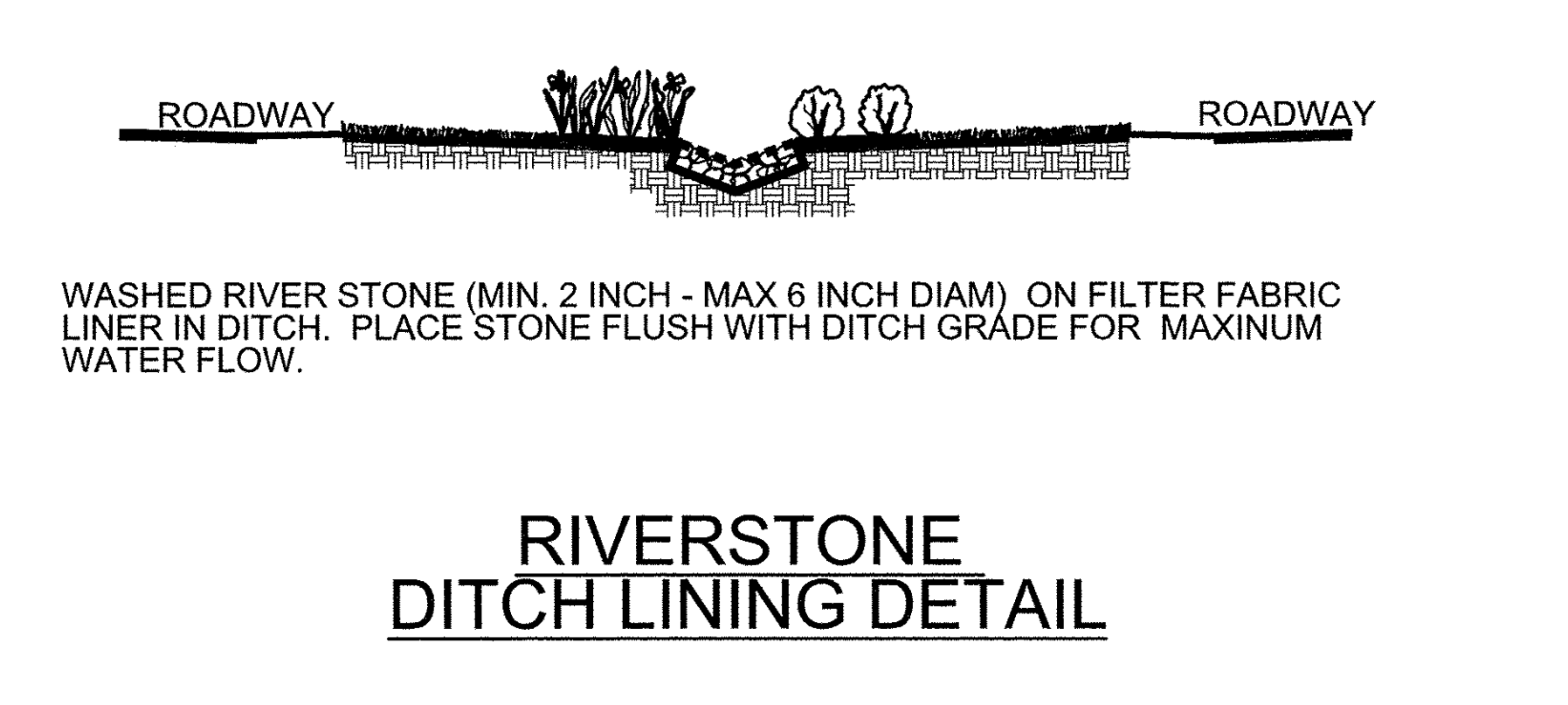

RIVERSTONE DITCH LINING DETAIL

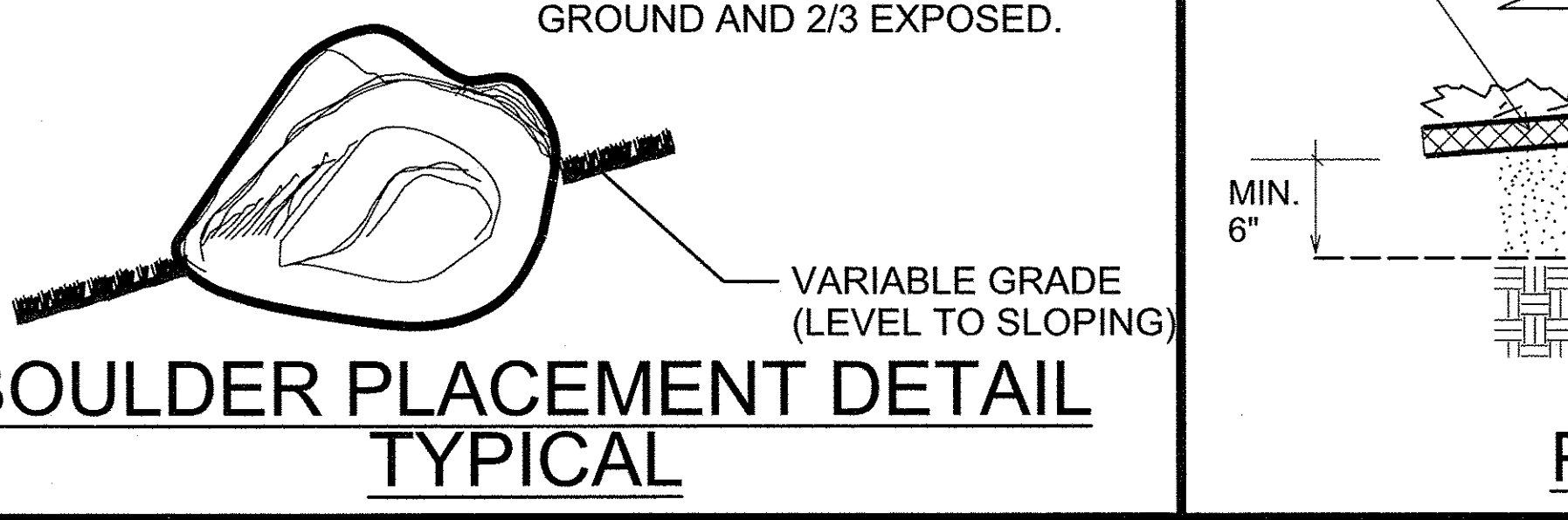

BOULDER PLACEMENT DETAIL TYPICAL

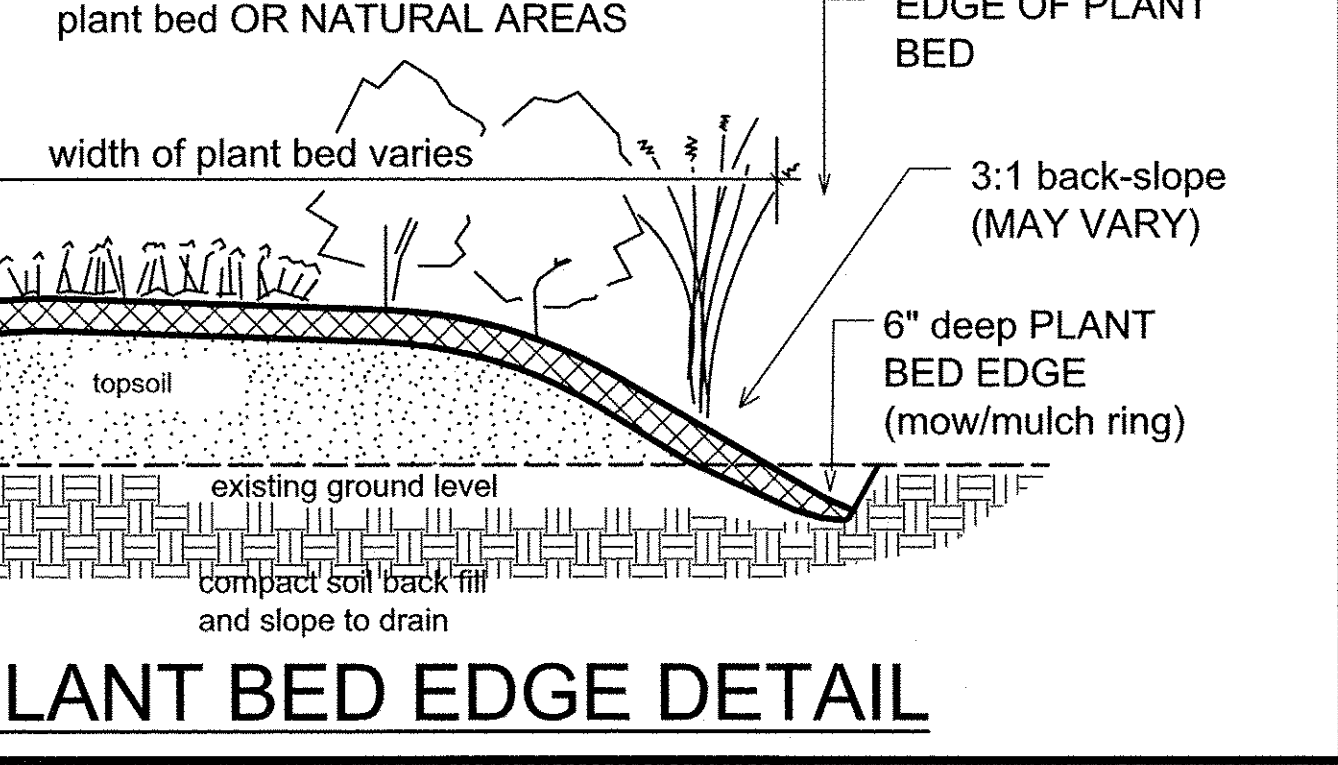

PLANT BED EDGE DETAIL

STANDARD SYMBOLS FOR LANDSCAPE ARCHITECTURE

NCDOT - Division 3 - Roadside Environmental Unit
803 Penderlea Highway Burgaw, NC 28425
Ph: 910-259-4919 Fax: 910-259-2781
Contact: Joe Chance

ARCADIS
G & M of North Carolina, Inc.
www.ARCADIS-US.COM
801 Corporate Center Drive, Suite 300
Raleigh, NC 27607-5073
Tel: 919/854-1282 Fax: 919/854-5448
NC License No. C-1869
Contact: Nick Nikolov

Landscape Enhancement Projects
Burgaw, North Carolina
Pender County
contract #:

NORTH CAROLINA LANDSCAPE ARCHITECTURE
1148
12/4/12
NICKOLAY A. NIKOLOV

prel. design date : December/2012
checked by & date :
final design date :

Details

T.I.P. #
WBS # 3703.3.22
FED I.D. #
sheet no : total sheet no :
L8 8